

Ersatzteile - spare parts TM 4

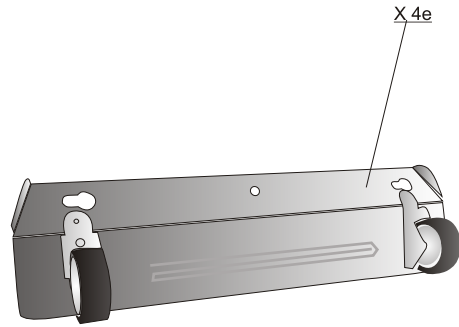

X 4b

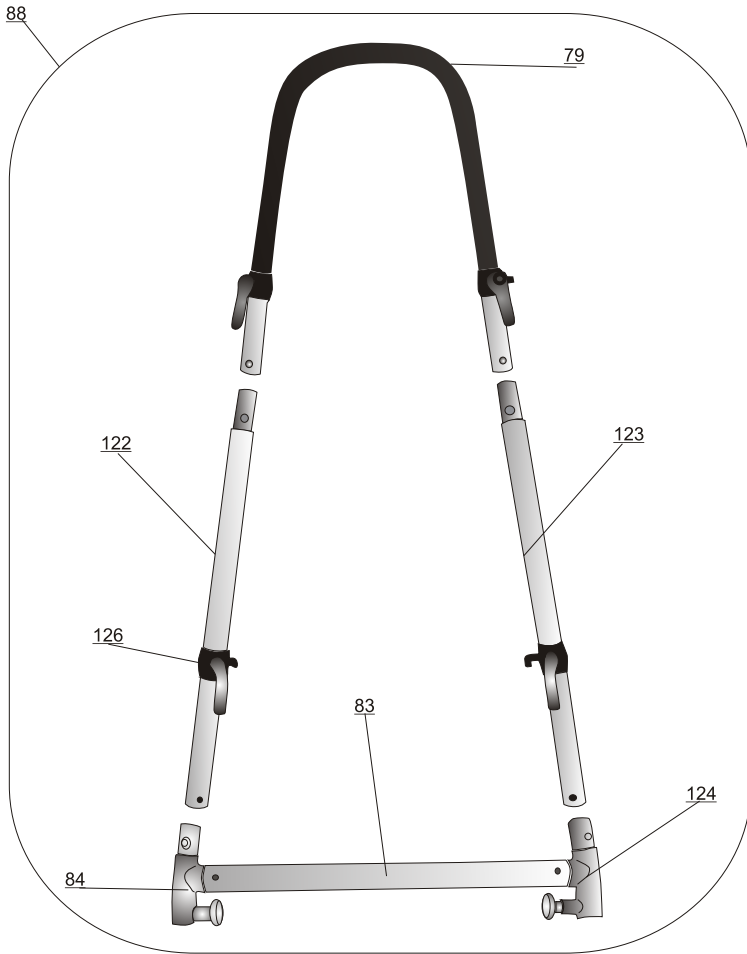
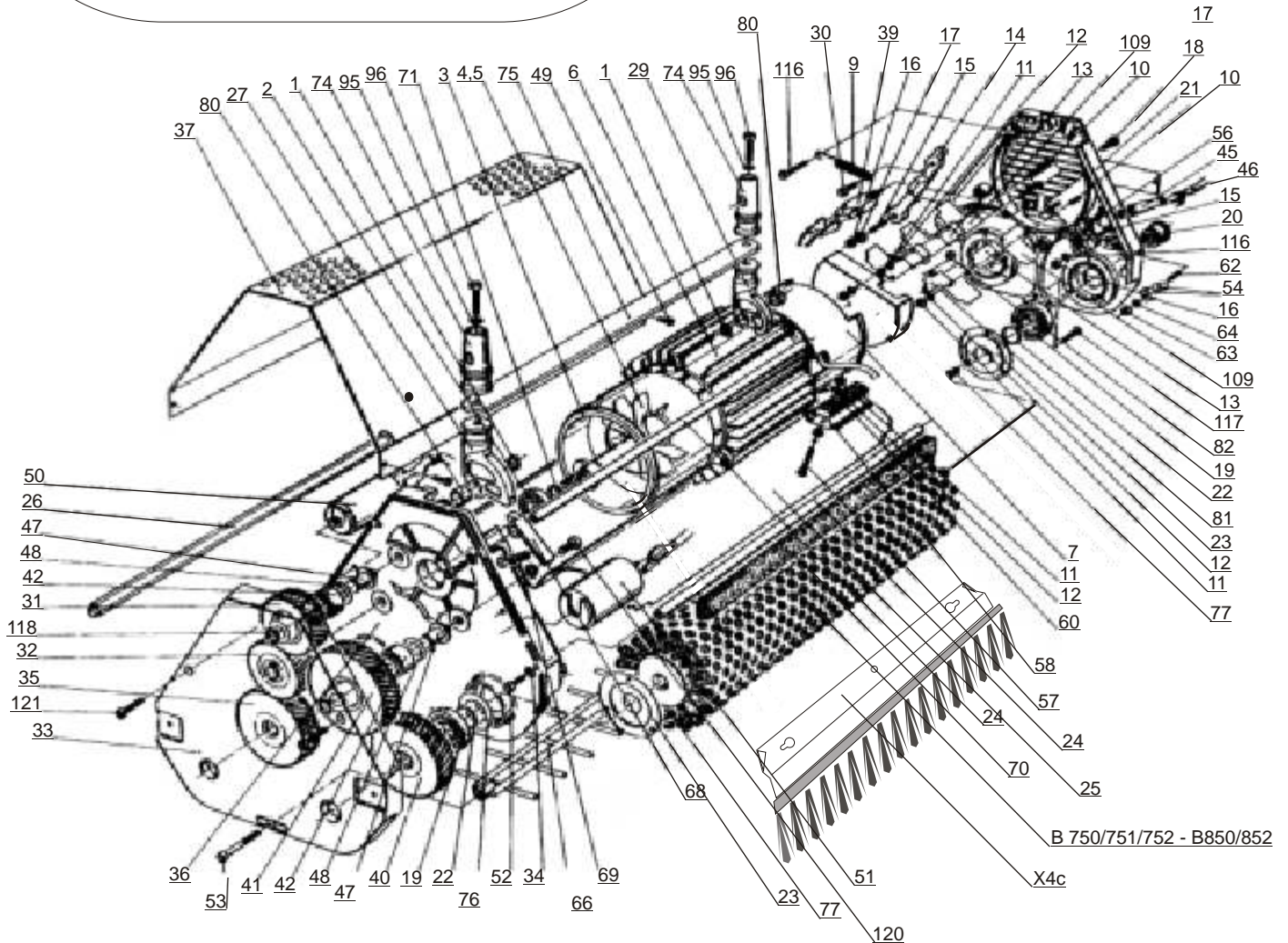
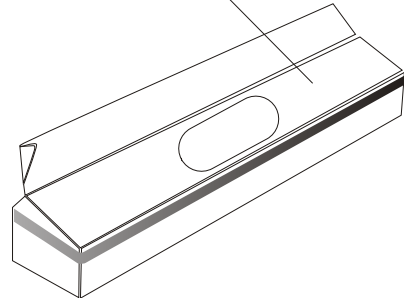

Ersatzteile - spare parts TM 4

Nr.	Bezeichnung	description	Nr	Bezeichnung	description
1	Sicherungsring A 12	Snapring A12	54	Klemmbügel/-schiene	Clamp strip
2	Kugellager 6002	Ballbearing 6002	55	Haltefeder	Spring
3	Zwischenstück G komplet	Distancepiece G	56	Klemmbacke	Cable clamp
4	Spannstift 3 x 20 A2	Split pin 3 x 20 A2	57	Zylinderschraube M3 x 16	Cylinder head screw M3 x 16
5	Lüfterrad	Ventilator	58	Drahthalteplatte	Wire fixing plate
6	Motor	Motor RFB 18/2-7PR	60	Klemmleiste	Terminal
7	Zwischenstück E	Distancepiece E	61	V - Ring	V- ring
8	Transportwagen	Trolley	62	Gewindestift	Worm srew
9	Zugfeder 10 x 1,2 x 64	Extension spring 10x1,2 x 64	62.1	Doppelrolle	Castor wheel
10	Gewindestift M3 x 35	Grub screw M3 x 35	63	Mutter M4	Nut M4
11	Mutter M3 Ms	Nut M5	64	Zahnscheibe M4 A2	Lock washer M4 A2
12	Federring M3	Spring ring M3	66	Kabelfang	Cableprotector
13	Mikroschalter	Microswitch	68	Stielsperre	Handle stop
14	Schaltteil komplet	Switchpart	69	Feder für Stielsperre	Handle stop-spring
15	Gewindestift M5 x 25	Grub screw M5 x 25	70	Gummidichtung	Rubber seal
16	Mutter M5	Nut M5	71	Sicherungsring A15	Snapring A15
17	Scheibe M5	Disc M5	74	Stielansatz Oberteil	Handle connector upper part
18	Zylinderschraube M5 x 12	Cylinder head screw	75	Flachstange	Flatbar
19	Kugellager 6003-2RS	Ballbearing 6003 - 2RS	76	Anlaufscheibe	Washer disc
20	Flansch	Flange	77	Schraube M3 x 5	Screw M3 x 5
21	Gehäuseblock E	Housing unit E cpl.	78	Zugschnäpper	Snap-in
22	Sprengtring A 17	Retainingring A 17	79	Stiel Oberteil	Handle, upper part
23	Fadenschutz	Protactive plate	80	Lagerbuchse	Bearing
24	Zugstange TM4	Motorstud	81	Rollenhebel	Rollerlever
25	Bürstenabdeckung	Brushcover	82	Rollenhebelhalterung	Rollerleverholder
26	Steckachse	Brush axle	83	Querrohr	Cross bar
27	Stielansatz Unterteil G	Handle connector lower part G	84	Stielknoten links komplet	T-piece left cpl.
29	Stielansatz Unterteil E	Handle connector lower part E	88	Stiel komplet	Handle complet
30	Schraube M6 x 16	Srew M6x16	95	Federring M6	Spring ring M6
31	Zahnrad 48 rechts	Gear 48 right	96	Schraube M6 x 30	Screw M6 x 30
32	Zahnrad 48 links	Gear 48 left	109	Isolierplättchen	Isolating plate
33	Getriebedeckung	Gearcover	116	Zylinderschraube	Cylinder head screw
34	Zahnscheibe M5	Lockwasher M 5	117	Linsensenk. M5 x 12	Screw M5 x 12
35	Zahnrad 66 rechts	Gear 66 right	118	Sicherungsring A10	Snapring A10
36	Gehäuseblock G	Housing unit E cpl.	120	Schraube M6 x 16	Screw M6 x 16
37	Haube elox.	Cover	121	Zylinderschraube M5 x 12	Cylinder head screw
39	Motorschutzschalter	Thermorelay	122	Stielunterteil	Handle, lower part
40	Zahnrad 66 links	Gear 66 left	123	Stielunterteil	Handle, lower part
41	Zahnrad 73 rechts	Gear 76 right	124	Stielknoten rechts komplet	Handle connector right, cpl.
42	Kugellager 6000	Ballbearing 6000	125	Zugentlastung	Tension reducer
45	Tülle	Grommet	126	Kabelhalter	Cableholder
46	Kabel	Cable	151	Fixierschraube für Renovator	Nut and bolt for Renovator
47	Lagerbolzen	Bearingpin	152	Stehbügel	Front upright
48	Paßscheibe	Disc	153	Rad, groß	Wheel, big
49	Zylinderschraube	Cylinder head screw	154	Achse für Transportwagen	Axle for transport trolley
50	Betriebskondensator	Run Capacitor	155	Gurt kpl. mit Blindnieten	Belt incl. with blind nuts
51	Anlaßkondensator	Start Capacitor	156	Tasse mit Haltefeder	Tray incl. clips
52	Zylinderschraube M5 x 12	Cylinder head screw M5 x 45	157	Lenkrolle inkl. Schrauben	Revolving wheel incl. screws
53	Schraube M5 x 45	Screw M5 x 45	158	Achse für Transportwagen	Axle for transport trolley
			159	Schraube für Achse	Screw for axle

Transportwagen / transport trolley TM 4

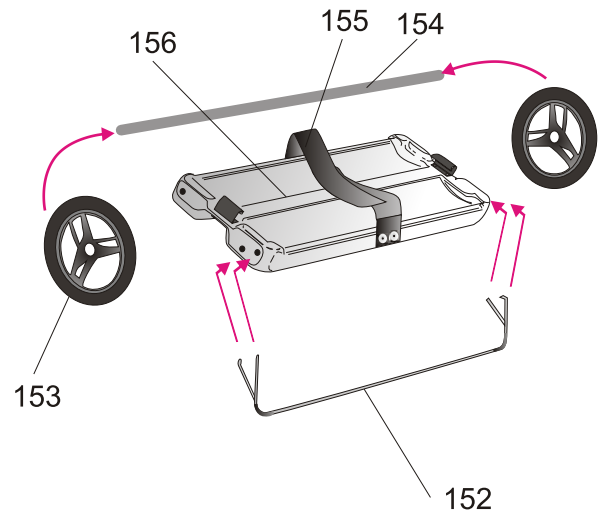

X 4e Neue Version
New version

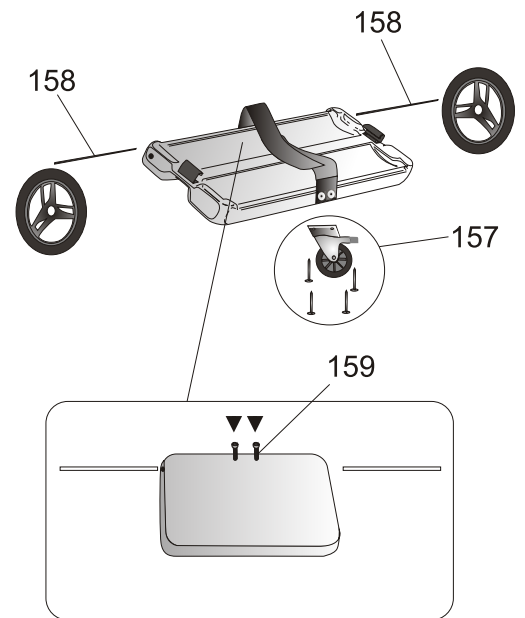

X 4e Übergangsvariante
Intermediate version

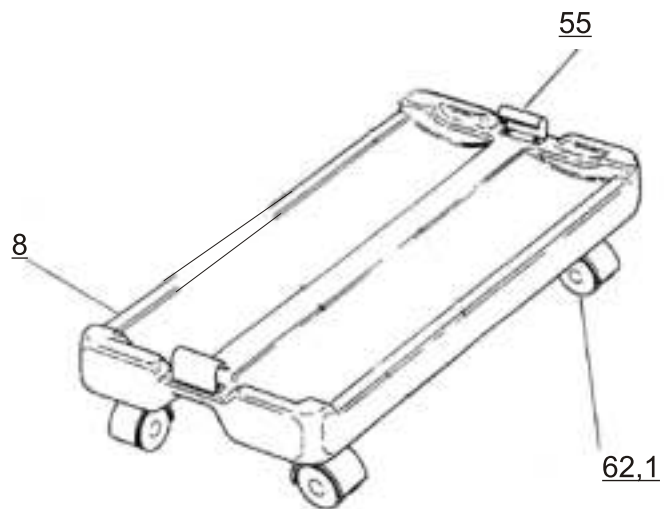

X 4e Alte Version
Old version

Ersatzteile - spare parts TM 4

E 1



Sicherungsring A 12
Snapping A 12

E 3



Zwischenstück G
Distancepiece G

E 4

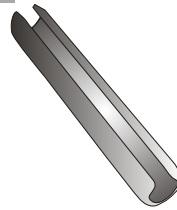

Spannstift 3 x 20 A2
Split pin 3 x 20 A2

E 5

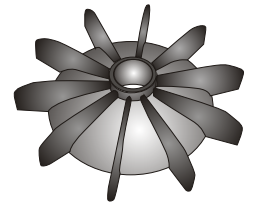

Lüfterrad
Ventilator

E 6

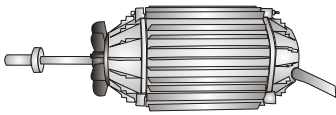

Motor RBF 0,18/2-7PR
Motor RBF 0,18/2-7PR

E 7



Zwischenstück E
Distancepiece E

E 8

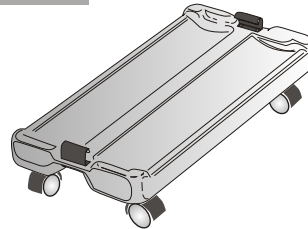

Transportwagen komplett
Trolley

E 9



Zugfeder 10x 1,2 x 64
Extension spring 10x 1,2 x 64

E 10

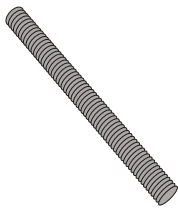

Gewindestift M3 x 35
Grub screw M3 x 35

E 11



Mutter M3 Ms
Nut M3 Ms

E 12



Federring M3
Spring Ring M3

E 13_L

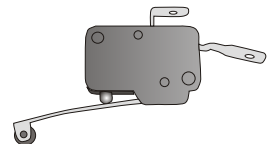

Microschalter
mit Rollenhebel
Microswitch incl. lever

E 13

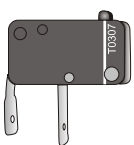

Microschalter
Microswitch

E 14

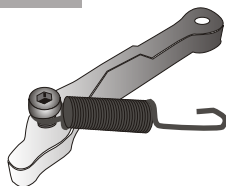

Schalthebel komplett
Switchpart

E 15

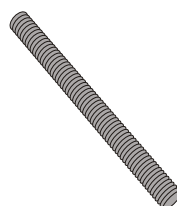

Gewindestift M5 x 25
Grub screw M5 x 25

E 16



Mutter M5
Nut M5

Ersatzteile - spare parts TM 4

E 17

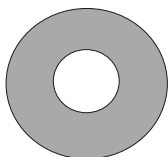

Scheibe M5
Disc M5

E 18

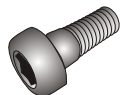

Zylinderschraube M5 x 12
Cylinder head screw M5 x 12

E 20



Flansch
Flange

E 21

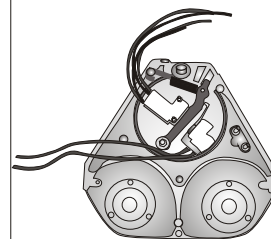

Gehäuseblock E komplett
Housing unit E complet

E 22

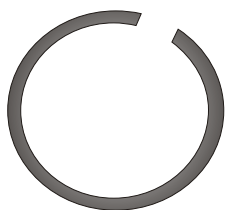

Sicherungsring A 17
Retainingring A 17

E 23

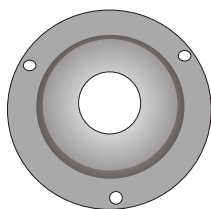

Fadenschutz
Protective plat

E 24

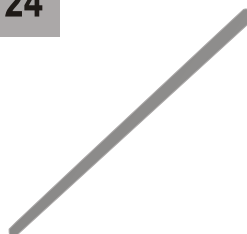

Zugstange
Motorstud

E 25

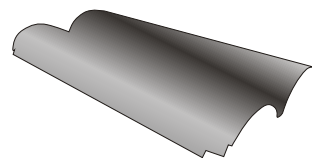

Bürstabdeckung
Brushcover

E 26

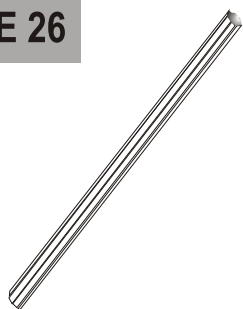

Steckachse
Brush axle

E 27

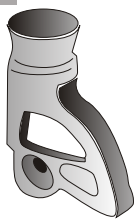

Stielansatz Unterteil G
Handle connector lower part G

E 29



Stielansatz Unterteil E
Handle connector lower part E

E 30

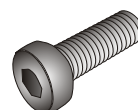

Schraube M6 x 16
Srew M6 x 16

E 31

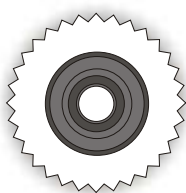

Zahnrad 48 rechts
Gear 48 right

E 32

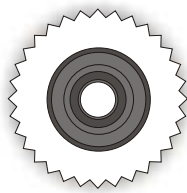

Zahnrad 48 links
Gear 48 left

E 33

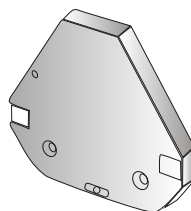

Getriebedeckel
Gearcover

E 34

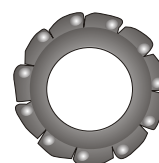

Zahnscheibe M5
Lock washer M5

Ersatzteile - spare parts TM 4

E 35

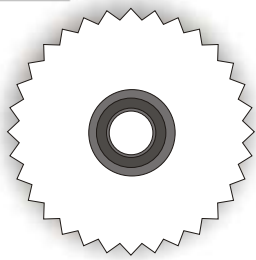

Zahnrad 66 rechts
Gear 66 right

E 36

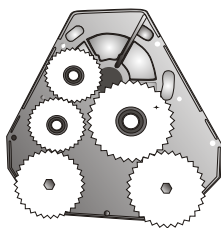

Gehäuseblock E komplett
Housing unit E complete

E 37

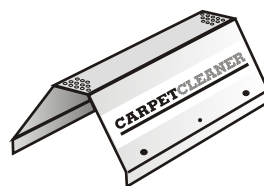

Motorhaube
Cover

E 39



Motorschutzschalter
Thermorelay

E 40

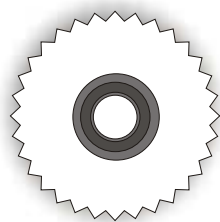

Zahnrad 66 links
Gear 66 left

E 41

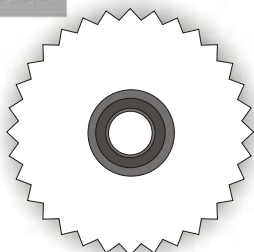

Zahnrad 73 rechts
Gear 73 right

E 45

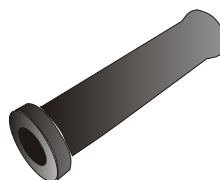

Tülle
Grommet

E 46



Kabel
Cable

E 47

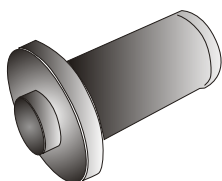

Lagerbolzen
Bearingpin

E 48

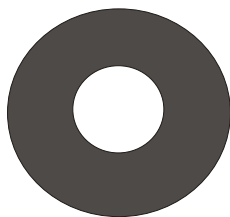

Paßscheibe
Disc

E 49

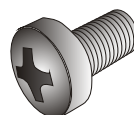

Zylinderschraube
Cylinder head screw

E 50

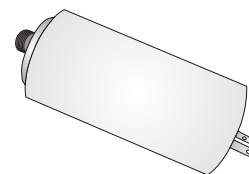

Betriebskondensator 10 mF
Run Capacitor 10 mF

E 51

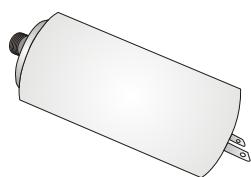

Startkondensator 12,5 mF
Start Capacitor 12,5 mF

E 52

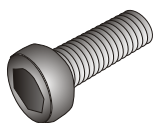

Zylinderschraube M5 x 12
Cylinder head screw M5 x 12

E 53

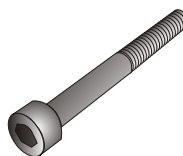

Schraube M5 x 45
Screw M5 x 45

E 54

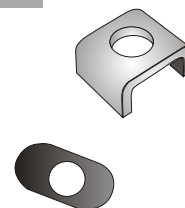

Klemmschiene
Clamp strip

Ersatzteile - spare parts TM 4

E 55

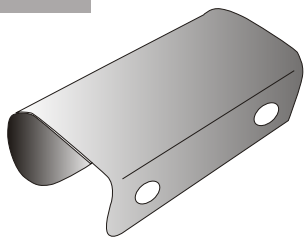

Haltefeder für Transportwagen
Spring

E 56

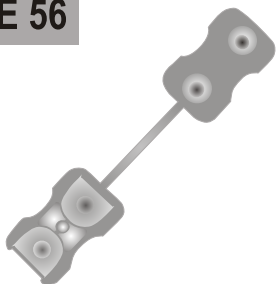

Klemmbake
Cable clamp

E 57

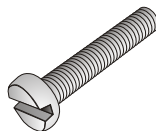

Zylinderschraube M3 x 16
Cylinder head screw M3 x 16

E 58

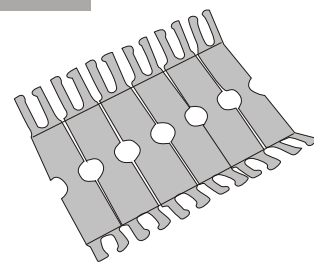

Drahthalteplatte
Wire fixing plate

E 60

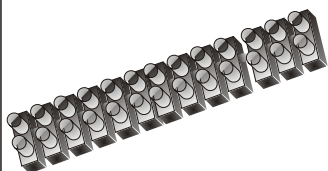

Klemmleiste EKL 1
Terminal

E 61

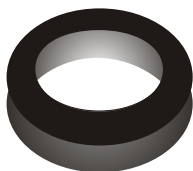

V-Ring
V-ring

E 62

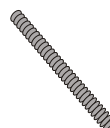

Gewindestift
Wormscrew

E 62.1

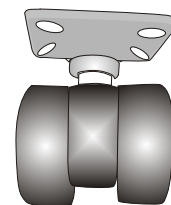

Doppelrolle
Castor wheel

E 63



Mutter M4
Nut M4

E 64

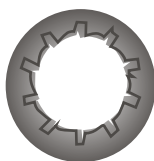

Zahnscheibe M4 A2
Lock washer M4 A2

E 66



Kabelfang
Cableprotector

E 68

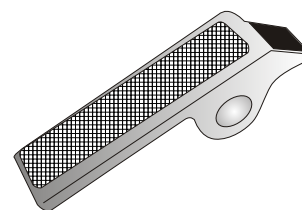

Stielsperre Alu
Handle stop

E 69



Feder für Stielsperre
Handle stop - spring

E 70

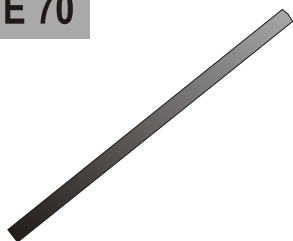

Gummidichtung
Rubber seal

E 71



Sicherungsring A 15
Snapping A 15

E 74

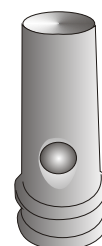

Stielansatzoberteil
Handle connector upper part

Ersatzteile - spare parts TM 4

E 75

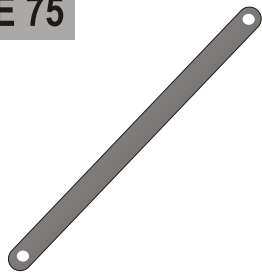

Flachstange
Flatbar

E 77



Schraube M3 x 5
Screw M3 x 5

E 78

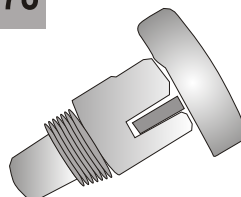

Zugschnäpper
Snap - in

E 79



Stiel Oberteil
Handle, upper part

E 83



Querrohr
Cross bar

E 84

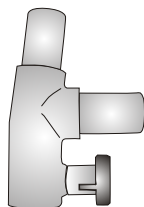

Stielknoten links
T-piece left

E 86



Tandemstange
Tandem bar

E 88



Stiel komplett
Handle complete

E 96

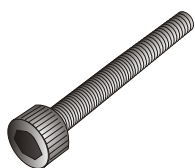

Schraube M6 x 30
Screw M6 x 30

E 109

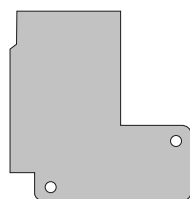

Isolierplättchen
Isolating plate

E 116

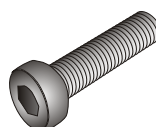

Zylinderschraube
Cylinder head screw

E 117



Linsensenk. M5 x 12
Screw M5 x 12

E 118



Sicherungsring A 10
Snapping A 10

E 121

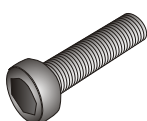

Zylinderschraube M5 x 12
Cylinder head screw M5 x 12

E 122

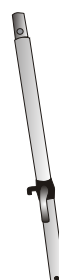

Stielunterteil links
Handle, lower part left

E 123

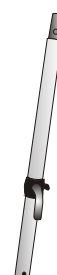

Stielunterteil rechts
Handle, lower part right

Ersatzteile - spare parts TM 4

E 124

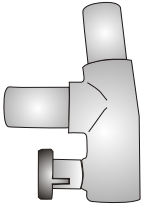

Stielknoten rechts
T-piece right

E 126

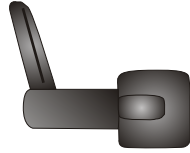

Kabelhaken
Cable holder

E 152

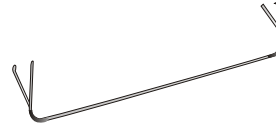

Stehbügel
Front upright

E 153



Rad, groß
Wheel, big

E 154



Achse für Transportwagen
Axle for transport trolley

E 155

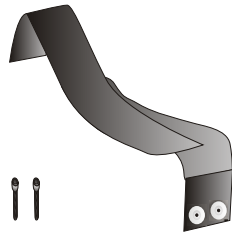

Gurt komplett mit Blindnieten
Belt incl. blind nuts

E 156

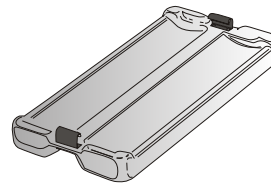

Tasse mit Haltefeder
Tray incl. clips

E 157

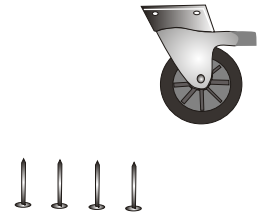

Lenkrolle inkl. Schrauben
Revolving wheel incl. screws

E 158



Achse für Transportwagen
Axle for transport trolley

E 159



Schrauben für Achse
Screw for axle