

Bissell®

Commercial

CROSSWAVE® COMMERCIAL HARD SURFACE CLEANER 3388 SERIES

What's in the Box? 3

Product View 3

Assembly 3

Filling the Clean Water Tank..... 4

Cleaning Your Floors 4

Emptying the Dirty Water Tank..... 5

Using the Self-Clean Cycle 5

After-Cleaning Care..... 6

Troubleshooting..... 7

Storing Your Machine..... 8

Warranty 8

Service..... 8

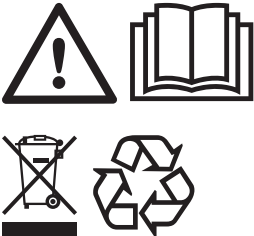
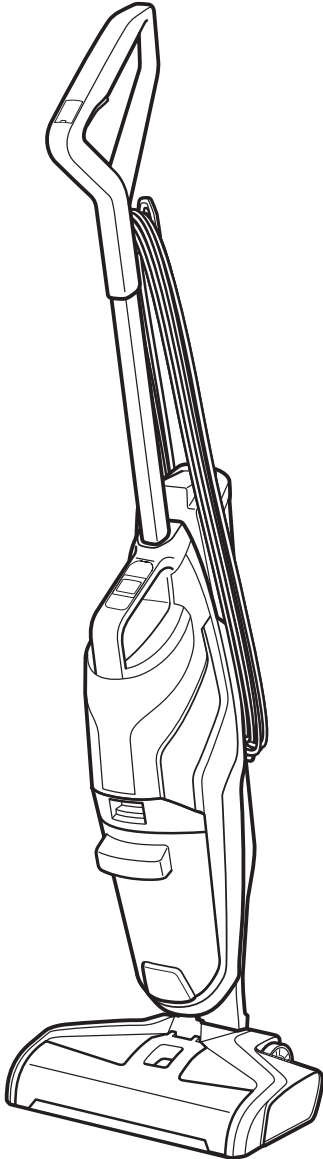

SYMBOL	EXPLANATION
	Caution.
	Read operator's manual.
	Risk of fire.
	Risk of electric shock.

SYMBOL	EXPLANATION
	For indoor use only.
	Protection against moving parts.
	Risk of automatic start-up.
	Use warm water, temperature up to 60°C.

SYMBOL	EXPLANATION
	Do not overwet carpet. Use only on carpet moistened by the cleaning process.
	Use only BISSELL® cleaning formulas intended for use with this machine.

IMPORTANT SAFETY INSTRUCTIONS

READ ALL INSTRUCTIONS BEFORE USING YOUR MACHINE.

When using an electrical machine, basic precautions should be observed, including the following:

WARNING

TO REDUCE THE RISK OF FIRE, ELECTRIC SHOCK OR INJURY:

- If the supply cable is damaged, it must be replaced by the manufacturer, its service agent or similarly qualified person in order to avoid a hazard.
- A hazard may occur if the machine runs over the supply cord.
- The machine has to be unplugged after use and before carrying out user maintenance on the machine.
- If your machine is fitted with a nonrewireable BS 1363 plug it must not be used unless a 13 amp (ASTA approved to BS 1362) fuse is fitted in the carrier contained in the plug. Spares may be obtained from your BISSELL supplier. If for any reason the plug is cut off, it must be disposed of, as it is an electric shock hazard should it be inserted into a 13 amp socket.
- If machine is not working as it should, has been dropped, damaged, left outdoors, or dropped into water; do not attempt to operate it and have it repaired at an authorized service center.
- Children should be supervised to ensure that they do not play with the machine.
- The plug must be removed from the socket-outlet before cleaning or maintaining the machine.
- Floor slippery when wet.
- Use only the type and amount of liquids specified under the operations section of this guide.
- Always connect to a properly earthed electrical socket. Do not modify earthed plug.
- Do not use flammable or combustible liquids with this machine.
- If foam or liquid escapes from the machine, switch OFF immediately.
- Clean the water level limiting device regularly and examine it for signs of damage.
- This machine is not intended for use by persons (including children) with reduced physical, sensory or mental capabilities, or lack of experience and knowledge.
- Operators shall be adequately instructed on the use of these machines.
- This machine is not suitable for picking up hazardous dust.

- Do not leave machine when it is plugged in. Unplug from outlet when not in use and before servicing.
- Use indoors only.
- Always install float before any wet pick-up operation.
- Do not use for any purpose other than described in this user guide. Use only manufacturer's recommended attachments.
- Do not pull or carry by cable, use cable as a handle, close door on cable, or pull cable around sharp edges or corners. Do not run machine over cable.
- Keep cord away from heated surfaces.
- Do not unplug by pulling on cable. To unplug, grasp the plug, not the cable.
- Do not handle plug or machine with wet hands.
- Do not put any object into openings. Do not use with any opening blocked; keep openings free of dust, lint, hair, and anything that may reduce air flow.
- Keep hair, loose clothing, fingers, and all parts of body away from openings and moving parts of the machine and its accessories.
- Turn OFF all controls before plugging or unplugging machine.
- Use extra care when cleaning on stairs.
- Do not use to pick up flammable or combustible materials (lighter fluid, gasoline, kerosene, etc.) or use in areas where they may be present.
- Do not pick up anything that is burning or smoking, such as cigarettes, matches or hot ashes.
- Do not use without filters in place.
- Do not turn your machine ON until you are familiar with all instructions and operating procedures.
- Keep machine on a level surface.
- Do not use machine in an enclosed space filled with vapours given off by oil-based paint, paint thinner, some moth-proofing substances, flammable dust, or other explosive or toxic vapours.
- Plastic film can be dangerous. To avoid danger of suffocation, keep away from children.
- Do not allow the supply cord to come into contact with the rotating brushes.
- Only use the socket outlet on the machine for purposes specified in the instructions.

SAVE THESE INSTRUCTIONS





ORIGINAL INSTRUCTIONS. FOR OPERATION ON A 220-240 VOLT A.C. 50-60 HZ POWER SUPPLY ONLY. THIS MACHINE IS INTENDED FOR COMMERCIAL USE, FOR EXAMPLE IN HOTELS, SCHOOLS, HOSPITALS, FACTORIES, SHOPS, OFFICES AND RENTAL BUSINESSES.

IMPORTANT INFORMATION

To reduce the risk of a leaking condition, do not store where freezing may occur. Damage to internal components may result.

What's in the Box?

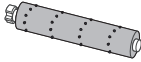
Standard accessories may vary by model. To identify what should be included with your purchase, please refer to the "Carton Contents" list located on the carton top flap.



			
Handle	Body	Brush Roll	Replacement Filter

Product View

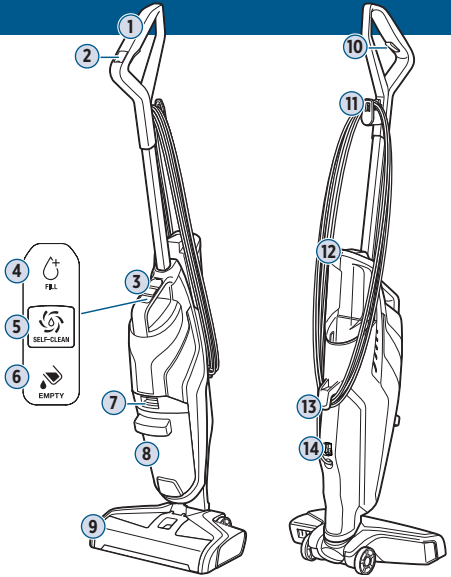
1. Upper Handle
2. Power Standby Button and Indicator Light
3. Carry Handle
4. Clean Water Tank Empty Indicator
5. Self-Clean Cycle Button
6. Dirty Water Tank Full or Clogged Indicator
7. Dirty Water Tank Release
8. Dirty Water Tank with Float Stack
9. Brush Roll Window
10. Solution Spray Trigger
11. Quick Release™ Cord Wrap
12. Clean Water Tank
13. Lower Cord Wrap
14. Power Switch

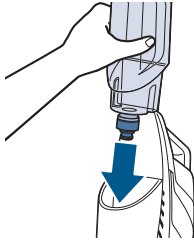

Assembly

		
1. Insert handle into body of machine until it clicks into place.	2. Align clean water tank with the grooves on the back of the machine and slide it until it clicks into place.	3. Wrap cord around upper and lower cord wraps. Note: To unwrap the cord, turn the Quick Release Cord Wrap down.

Filling the Clean Water Tank

View our full lineup of powerful carpet cleaning formulas at BISSELL-commercial.co.uk.



Always use genuine BISSELL® Commercial formulas in your machine. Other formulas may harm the machine. **Do not use boiling water. Do not heat water or tank in microwave.**

<p>1. Pull the clean water tank up to remove. Unscrew the cap from the bottom of the tank.</p>	<p>2. Add formula* and warm tap water (140°F/60°C max).</p> <p>BISSELL Commercial Formula (6:1 water to formula ratio): Add 148 mL of formula. Add water to MAX FILL line.</p> <p>For other recommended formula: Follow manufacturers solution ratio for cleaning and sanitizing hard floors and fill to MAX FILL line.</p>	<p>3. Screw the cap back on, align clean water tank with the grooves on the back of the machine and slide it until it clicks into place.</p>

*Compatible BISSELL formulas include: BISSELL Commercial Multi-Surface Formula

Cleaning Your Floors



<p>1. Plug into a properly grounded outlet. Press power switch on back of machine to ON position.</p>	<p>2. Press the power standby button on the handle to begin cleaning.</p> <p>Recline to start the brush roll spinning. Brush roll will not spin when machine is upright.</p>	<p>3. Before each use, hold the solution spray trigger for 10 seconds to prime the system with cleaning solution.</p> <p>LED lights will illuminate when holding the trigger. Bubbles will appear in the brush roll window when the solution is flowing.</p>

ATTENTION This machine is designed to be used on sealed hard floors.

WARNING To reduce the risk of fire and electric shock due to internal component damage, use only BISSELL Commercial cleaning formula intended for use with the hard floor device.

Cleaning Your Floors (continued)

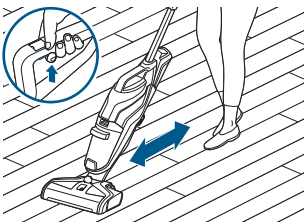

4. Hold the trigger to apply solution on forward and backward passes. For tough messes, hold the machine over the mess and use short passes.

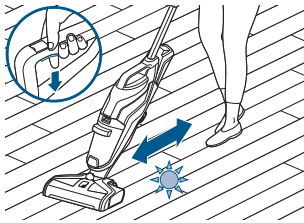

5. Release the trigger and make a backward pass without dispensing solution. To dry floors faster, make additional dry passes.

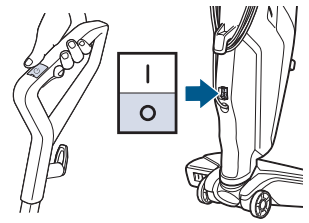

6. Press the power standby button to put the machine in standby mode.

Press power switch on back of machine to OFF position.

Emptying the Dirty Water Tank

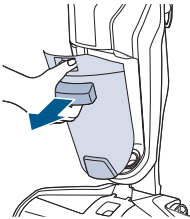

1. Press the button on top of the tank, grab the front handle and pull the tank out.

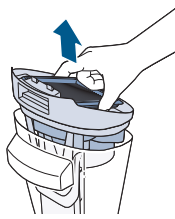

2. Hold the top of the tank near the sides of the filter and pull up to remove.

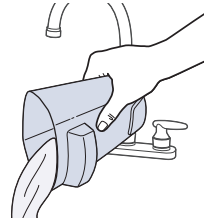

3. Pour dirty water down the sink and rinse the tank.

Using the Self-Clean Cycle

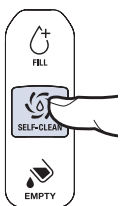

1. With machine in standby mode and in the upright position, press the self-clean button. The dirty water tank indicator will flash 5 times and then turn solid amber. This is a reminder to empty the dirty water tank.

2. Press the self-clean button again. The machine will run two cycles:
15 second wash cycle: LED lights on foot turn ON. Solution will flow on brush roll.
45 second dry cycle: LED lights on foot turn OFF. No solution flowing on brush roll.

3. Machine will shut off when self-cleaning is complete. Repeat as necessary. Empty dirty water tank when finished.

ATTENTION Do not overwet carpet or hardwood floors. Be careful not to run over loose objects or edges of area rugs. Stalling the brush may result in premature belt failure.

After-Cleaning Care



Important: Clean and dry filter after use to maximize performance. Replace filter every 3 months.

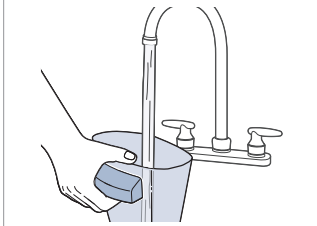

1. Empty the dirty water tank following steps on page 5. Rinse the tank.

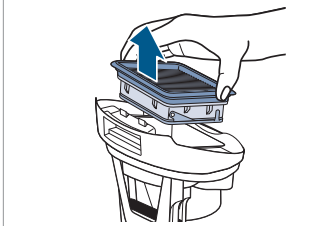

2. Remove the filter by holding the sides and pulling up.

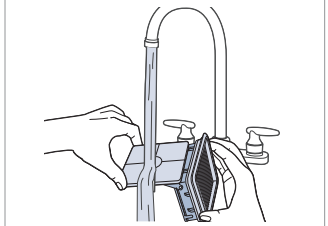

3. Wash filter and screen with warm water and mild detergent.

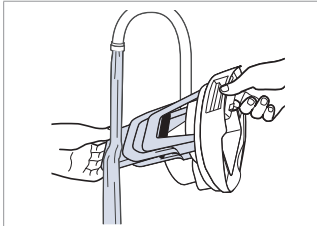

4. Rinse the float on the dirty water tank cover.

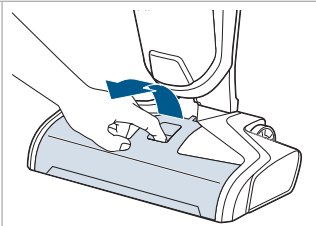

5. Grab the front of the brush window and pull up to remove.

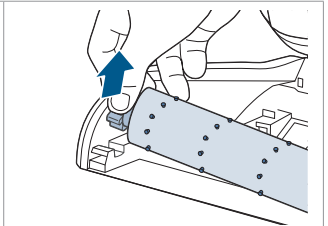

6. Remove the brush roll by pulling the tab.

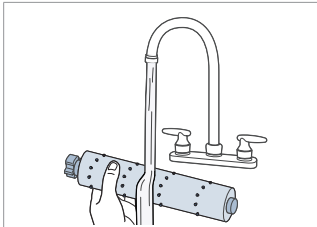

7. Hand wash with mild detergent. Place in drying tray.

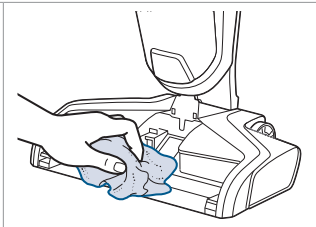

8. Wipe out the brush roll chamber.

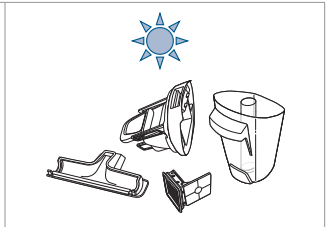

9. Leave all parts out to dry before reassembling.

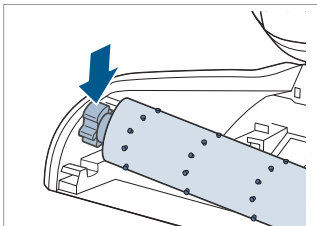

10. Place brush into the right side of the foot first. Press left tab down to lock into place.

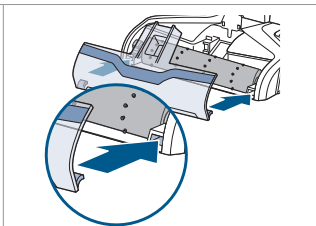

11. Reinstall the brush roll window by lining up tabs on the edges of the foot.

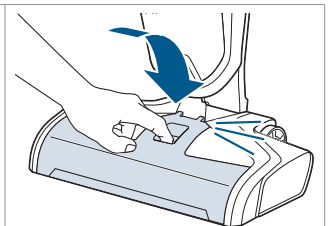

12. Press the window back so it clicks into place.

! WARNING To reduce the risk of fire, electric shock or injury, turn power OFF and disconnect plug from electrical outlet before performing maintenance or troubleshooting.

Troubleshooting

Below are some of the issues you may run into. If you don't see the issue you're experiencing below, visit support.BISSELL.com.

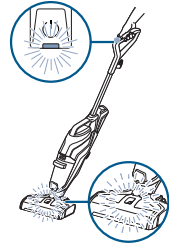

Clean Water Tank Indicator

Blinks, turns solid amber:
Clean water tank is empty. Refill tank.

Dirty Water Tank Indicator

Blinks, turns solid amber, machine turns off: Dirty water tank is full.

Blinks, turns solid amber, machine will not turn on: Filter is not installed properly. Reinstall filter.

Nozzle and Handle Lights

Solid red light on handle, flashing then solid white light on nozzle: Brush roll is missing, incorrectly aligned or not a genuine BISSELL® Commercial replacement. Machine will not turn on.

Problem	Possible Cause	Remedies
Reduced or no spray	Clean water tank is empty.	Refill tank.
	Clean water tank is not seated completely.	Turn power OFF. Remove and reseat tank.
	System isn't completely primed.	Hold trigger for 10 to 15 seconds to make sure the solution has flowed to the spray tips.
	Brush window is not latched in place.	Turn power OFF. Unplug machine and reinstall brush window.
	Not holding trigger to spray solution.	Hold trigger continuously while using the machine.
	Spray tips on foot clogged.	Use a pin to clean the spray tips located underneath the brush window.
Loss of suction power	Tanks may not be seated properly.	Turn power OFF. Reinstall tanks so they fit properly.
	Dirty water tank is full.	Empty dirty water tank.
	Brush window is not latched in place.	Turn power OFF. Unplug machine and reinstall window.
	Debris channel in foot is clogged by debris.	Clean the channel with a paper towel.
	Filter clogged by debris.	Clear debris clogging the filter screen. Clean the filter.
Brush roll isn't turning	Brush roll is not installed properly.	Turn power OFF. Unplug machine. Follow instructions on page 6 to reinstall brush roll.
	Machine is standing upright.	Recline machine to turn brush roll on.
	Brush roll is obstructed.	Turn power OFF. Unplug machine and remove brush window and brush roll to remove obstruction.
Machine won't turn ON	Brush roll is obstructed.	Unplug machine to reset the system. Remove the brush window and brush roll to clear the obstruction.
	Handle installed incorrectly.	Remove the handle and reinstall following instructions on page 3.
Leaking	Clean water tank cap is not closed properly.	Remove the clean water tank and reapply the cap.
Streaking	Too much water applied.	Go over area without spraying water.
	Previous floorcare products used.	Contact product manufacturer regarding how to remove.

Note: Any other servicing should be performed by an authorized service representative.

⚠️ WARNING To reduce the risk of fire, electric shock or injury, turn power OFF and disconnect plug from electrical outlet before performing maintenance or troubleshooting.

Storing Your Machine

Store machine in a protected, dry area. Since this product uses water, it must not be stored where there is danger of freezing. Freezing will damage internal components and may void the warranty.

Warranty

This warranty gives you specific legal rights, and you may also have other rights which may vary from country to country. If you need additional instruction regarding this warranty or have questions regarding what it may cover, please contact BISSELL® Commercial Consumer Care by e-mail or telephone as described below.

Limited One-Year Commercial Warranty

Subject to the *EXCEPTIONS AND EXCLUSIONS identified below, upon receipt of the product BISSELL Commercial will repair or replace (with new, refurbished, lightly used, or remanufactured components or products), at BISSELL Commercial's option, free of charge from the date of purchase by the original purchaser, for one year, any defective or malfunctioning part. See information below. This warranty does not apply to fans or routine maintenance components such as filters, belts, or brushes. Damage or malfunction caused by negligence, abuse, neglect, unauthorized repair, or any other use not in accordance with the user guide is not covered.

BISSELL Commercial is not liable for incidental or consequential damages of any nature associated with the use of this product. BISSELL Commercial's liability will not exceed the purchase price of the product. Some countries do not allow the exclusion or limitation of incidental or consequential damages, so the above limitation or exclusion may not apply to you.

*Exceptions and Exclusions From the Terms of the Limited Warranty

This warranty is exclusive and in lieu of any other warranties, either oral or written. Any implied warranties which may arise by operation of law, including the implied warranties of merchantability and fitness for a particular purpose, are limited to the one-year duration from the date of purchase as described above. Some countries do not allow limitations on how long an implied warranty lasts so the above limitation may not apply to you.

Note: Please keep your original sales receipt. It provides proof of date of purchase in the event of a warranty claim.

Service

If your BISSELL Commercial product should require a service, for information about repairs and replacement parts, or for questions about your warranty, please contact the distributor where the product was purchased.

If your query remains unresolved, please visit BISSELL-commercial.co.uk.



©2022 BISSELL Inc. All rights reserved.

BISSELL International Trading Company BV, Postbus 12874, 1100 AW Amsterdam Zuidoost, The Netherlands
BISSELL product imported into UK by: Beam Group, Unit 400, Buckingway Business Park, Swavesey CB24 4UQ
Part Number 1633459 06/22 RevA